



NOCTUA NM-AM5/4-MP78 chromax.black

Mounting Kit

The NM-AM5/4-MP78 is a SecuFirm2™ mounting upgrade kit that allows Noctua CPU coolers with 78mm mounting pitch (see detailed compatibility information) to be upgraded to AMD's AM5 and AM4 platforms. True to the SecuFirm2™ tradition, it combines outstanding reliability, optimal contact pressure and easy, straightforward installation in order to enable Noctua users to continue using their heatsinks on AMD's latest Ryzen processors. The chromax.black version with its all-black parts is a perfect match for Noctua's chromax.black line heatsinks.

For Noctua coolers with 78mm mounting pitch

The NM-AM5/4-MP78 kit is compatible with a wide range of Noctua CPU coolers that use 78mm mounting pitch, whereas heatsinks with 83mm mounting pitch must use the MP83 version. Please refer to our detailed compatibility information to check which kit is right for your cooler.

Tailor-made for AM5/AM4

Aiming to cut costs, many manufacturers use cross-platform parts for both AMD and Intel, which can cause compatibility issues. Noctua's SecuFirm2™ mounting system for AM5 and AM4 has been tailor-made for these sockets in order to ensure optimal compatibility and ease of installation.

chromax.black version

With all-black mounting bars and thumb screws, the chromax.black versions of the NM-AM5/4 kits are ideal for upgrading chromax.black line coolers. Featuring the same premium grade coating as the original mounting parts, they allow maintaining the same consistent black stealth design.

Backwards compatibility

Noctua CPU coolers are renowned for being safe, long-term investments that can be used for several CPU generations. Accordingly, even coolers that are 15 years or older can be upgraded to the latest AMD Ryzen platform using this mounting kit.

NM-AM5/4-MP78 chromax.black MOUNTING KIT SPECIFICATIONS

Socket compatibility AMD AM5

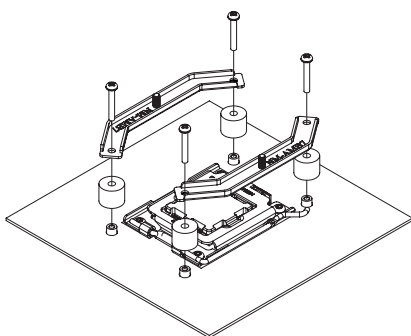

Please note that this NM-AM5/4-MP78 kit is compatible with heatsinks with 78mm mounting pitch only. For heatsinks with 83mm mounting pitch, the NM-AM5/4-MP83 kit must be used instead.

To find out how to determine if your cooler uses 83mm or 78mm mounting pitch, please see: www.noctua.at/mounting-pitch

For detailed, up-to-date socket compatibility information please visit: ncc.noctua.at/socket-compatibility-overview

LOGISTIC DATA

Product name	Noctua NM-AM5/4-MP78 chromax.black
EAN	9010018201376
UPC	841501121371
Packaging dimensions (HxWxD)	153x110x30 mm
Weight incl. packaging	102 g
Warranty	6 years
Packaging unit	60 pcs
Packaging dimensions / unit (HxWxD)	350x325x320 mm
Weight incl. packaging / unit	6.80 kg

SCOPE OF DELIVERY

- Black NM-AM5/4-MP78 chromax.black mounting kit